

Data Sheet



Article number: 12621000270700

Description: Threaded pin 621 000 270.700
For M27

Measures

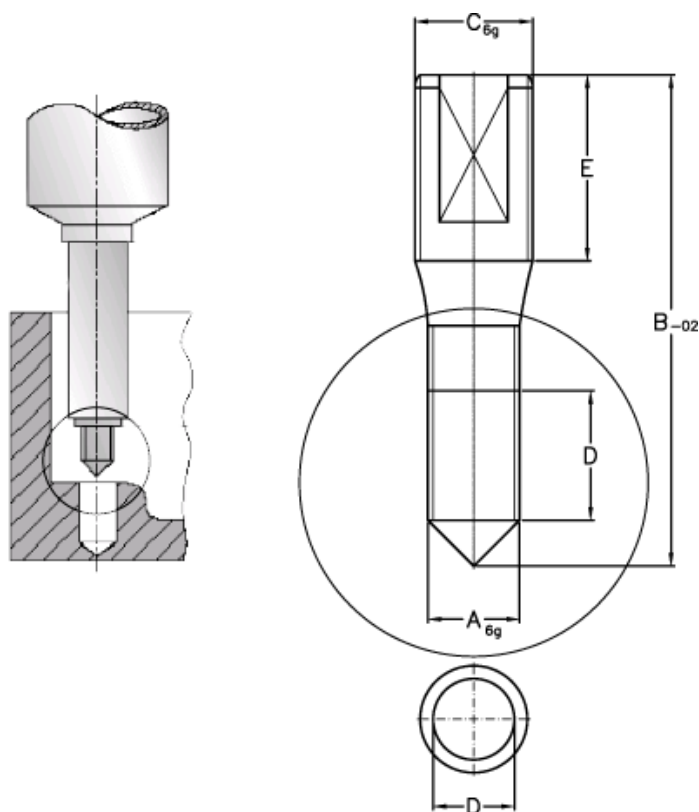

A = M27
B = 180.0
C = M30
D = 46.0
E = 48